



NPD12-45Ah

Valve-regulated lead-acid battery



DEEP CYCLE SERIES

Characteristics

Nominal voltage	12V (6 cell per unit)	
Nominal capacity at 10 hours rate/10.8V (25°C)	45 Ah	
Capacity (25°C)	20 Hours rate/10.8V	47.8 Ah
	5 Hours rate/10.8V	38.4 Ah
Terminal type	T14	
Torque	5.1±0.6 N.m	
Approx. internal resistance (25°C)	7.5 mΩ	
Dimensions	Length	197±2 mm (77.5 inch)
	Width	165±2 mm (65 inch)
	Height	170±2 mm (67 inch)
	Total height	170±2 mm (67 inch)
Design Life (stand-by)	JIS at 25°C	10 years
	Eurobat at 20°C	10/12 years
Weight	14.3 kg (31.5 lbs) ±3%	
Nominal operating temperature	25°C±3 (77±5°F)	
Operating temperature range	Discharge	-15°C~50°C (5°F~122°F)
	Charge	-10°C~50°C (14°F~122°F)
	Storage	-20°C~50°C (-4°F~122°F)
Float charging voltage at 25°C	13.5V~13.8V	
Cyclic charging voltage at 25°C	14.5V~15.0V	
Temperature compensation	Float (mV/°C/Block)	-18
	Cycle (mV/°C/Block)	-30
Max. charging current (A)	12A	
Max. discharge current for 5 seconds	400A	
Self discharge rate (25°C)	≤3%/month	
Battery container ABS UL94-HB	V-0 optional	

Overview

NPP Power Deep Cycle Series are manufactured specifically to provide outstanding performance in deep cycling applications. The batteries are designed using enhanced alloy contents plates and active paste materials.

Dimensions & Terminal Type (mm)

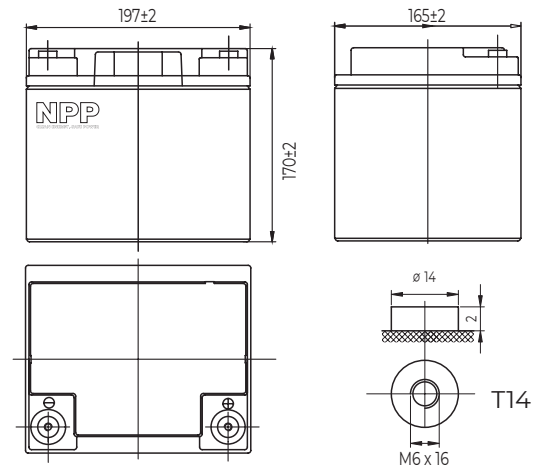

Certification & Compliances



Compliant to: EUROBAT, RoHS, WEEE's and Reach.
Manufactured according to IEC 60896-21 / 22

Construction

Component	Positive Plate	Negative plate	Container	Separator	Electrolyte	Safety valve	Terminal
Raw material	Lead dioxide	Lead	ABS (V-0 opt.)	AGM	Sulfuric Acid	Rubber	Copper

Constant current discharge characteristics at 25°C

(Ampere/battery)

F.V/Time	10min	15min	30min	60min	2h	3h	4h	5h	8h	10h	20h
9.60V	100	77.1	46.1	28.4	16.4	11.8	9.46	8.08	5.55	4.58	2.43
9.90V	97.1	75.3	45.2	27.9	16.3	11.8	9.40	8.03	5.52	4.57	2.42
10.2V	93.1	72.5	43.8	27.2	16.2	11.7	9.33	7.98	5.48	4.56	2.42
10.5V	89.1	70.0	42.8	26.4	16.0	11.6	9.27	7.92	5.45	4.53	2.40
10.8V	84.1	66.3	41.2	25.5	15.6	11.3	8.99	7.68	5.28	4.50	2.39

Constant power discharge characteristics at 25°C

(Watts/battery)

F.V/Time	10min	15min	30min	60min	2h	3h	4h	5h	8h	10h	20h
9.60V	1081	847	518	323	190	139	111	95.5	66.0	54.7	29.1
9.90V	1048	826	507	319	189	138	111	94.9	65.6	54.6	29.1
10.2V	1005	796	492	310	188	137	110	94.3	65.1	54.4	29.0
10.5V	962	769	480	301	185	137	109	93.6	64.7	54.1	28.8
10.8V	908	728	462	291	180	132	106	90.8	62.7	53.7	28.6

The above characteristics represent average values and can be obtained within three charge and discharge cycles. The batteries must be fully charged before testing. The data in this document is subject to change without notice and become contractual only after written confirmation. Please contact NPP Power for the latest available version.

NPP Power (Vietnam) Co.,Ltd

Lot A22.3, Road C4, Thanh Thanh Cong Industrial Zone,
An Hoa Village, Trang Bang District, Tay Ninh Province,
Vietnam

Guangzhou NPP Power Co, Ltd.

No.67 Lianglong Road, Huashan Town, Huadu District,
Guangzhou, China
Email: info@nppower.com.cn Tel. +86 20 37887 390

NPD12-45Ah

Valve-regulated lead-acid battery

DEEP CYCLE

SERIES

Discharge characteristics (25°C)

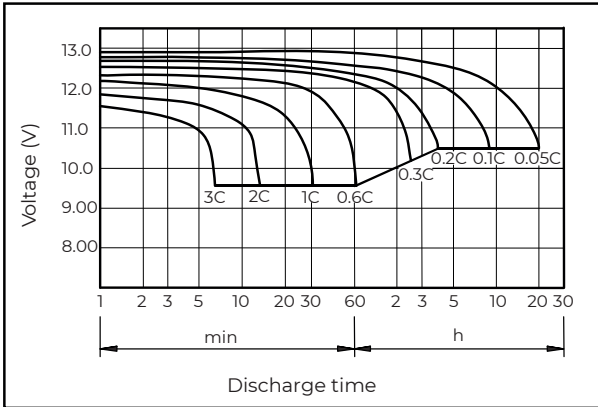

Charging characteristics (25°C)

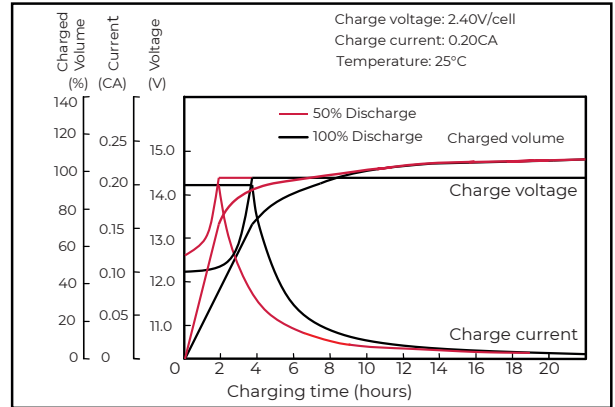

Temperature effects on capacity

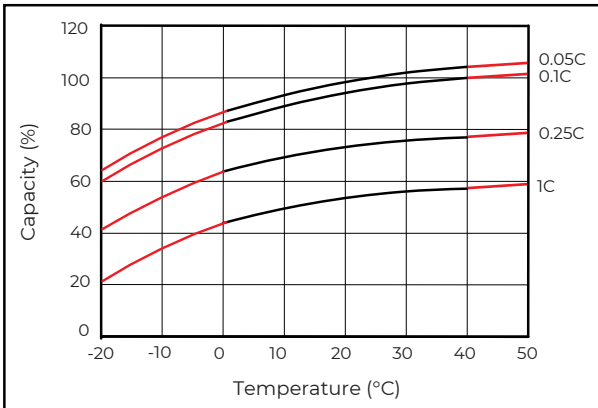

Self-discharge characteristics

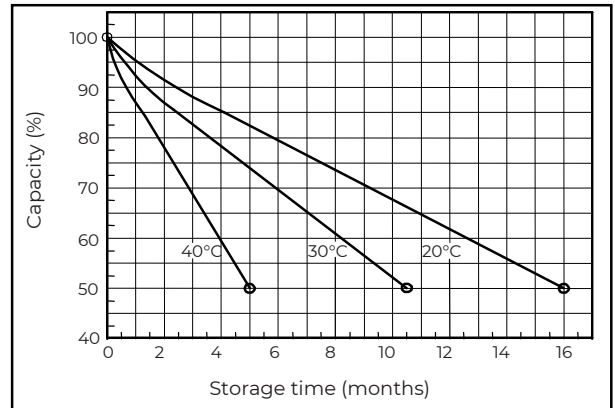

Floating life on temperature

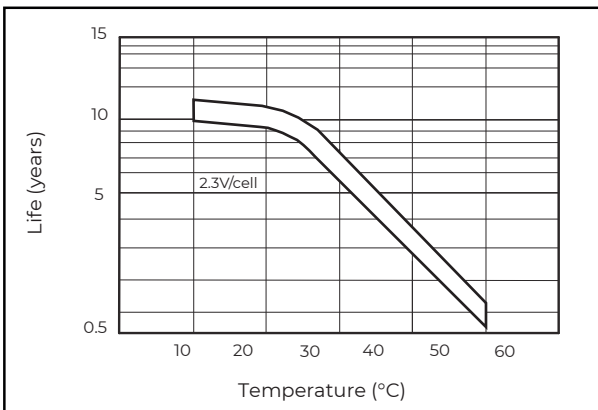

Cycle life on D.O.D (25°C)

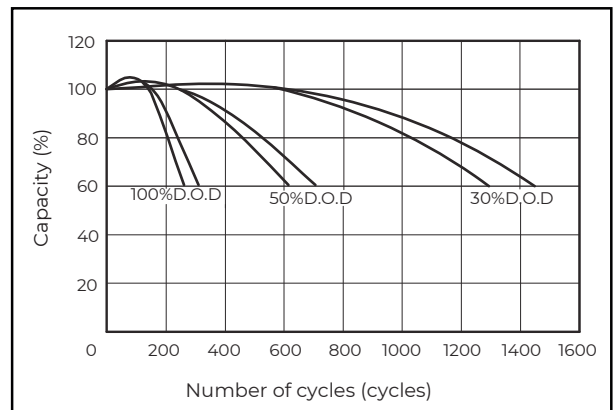

Relationship for OCV and capacity (25°C)

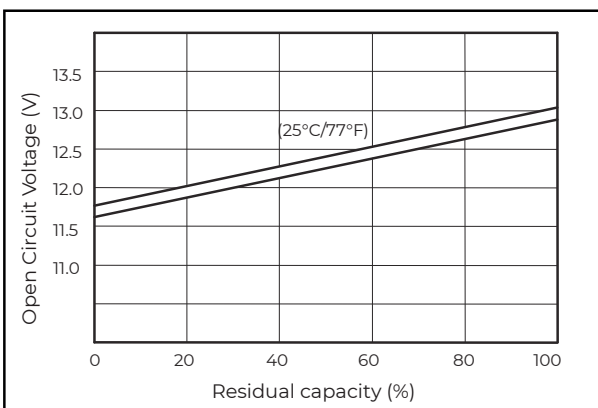

Charging voltage VS temperature

